

ITEM NO.	PART NUMBER	DESCRIPTION	DESCRIPTION 2	QTY
1	FB-060-2500-2	BEAM, PULTRUDED STOCK	SERIES 2500 x 60 in, GRAY	1
2	TG0688-0004	BUSHING	11/16 in x 3-1/8 in	4
3	TG0813-0006	BUSHING	13/16 in x 3-1/8 in	2
4	TG0688-0003	BUSHING	11/16 in x 4-1/16 in	2
5	FOAM	-	-	1
6	EC25-0003-2	END CAP	SERIES 2500, GRAY	2
7	DM-0046	MOUNT ASSEMBLY, DEADEND	HD	1
8	HB0750-0001	HEX BOLT	3/4 in - 10 x 5-1/2 in	2
9	LW0750-0001	LOCK WASHER	3/4 in	2
10	HN0750-0001	HEX NUT	3/4 in - 10	2
11	SW0688-0002	SQUARE WASHER	11/16 in, 3-1/2 in x 1/4 in	4
12	LW0625-0004	LOCK WASHER	5/8 in	2
13	EN0625-0003	EYE NUT	5/8 in - 11	4
14	TR0625-0001	THREADED ROD	5/8 in - 11 x 7-1/2 in	2

PUPI[®]
www.pupicrossarms.com

REVISIONS			
REV.	DESCRIPTION	DATE	INITIALS
1.0	ADDED REPLACES PREVIOUS ITEM NOTE IN TITLE BLOCK	2011-11-29	EFH
1.1	REDRAWN IN SOLIDWORKS	2013-02-19	RAF

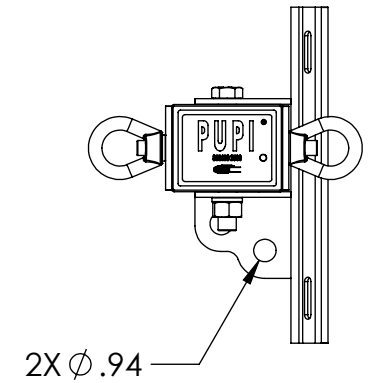
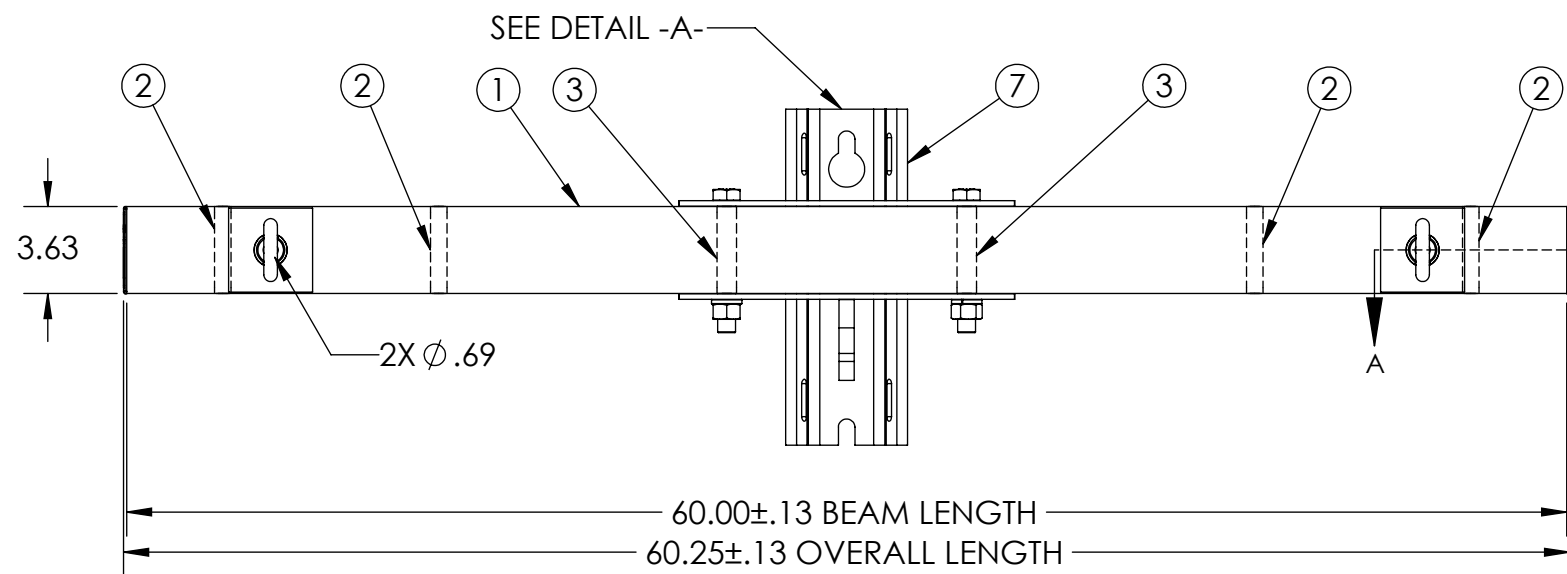
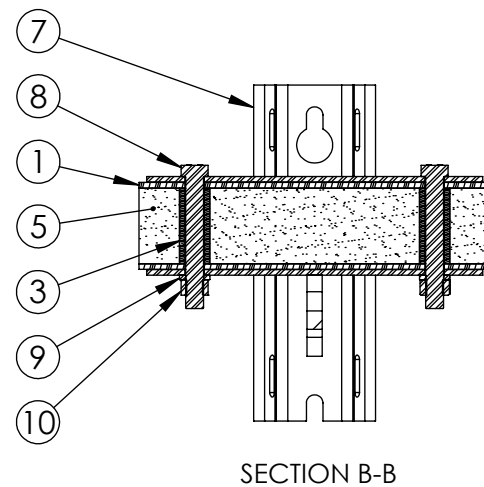
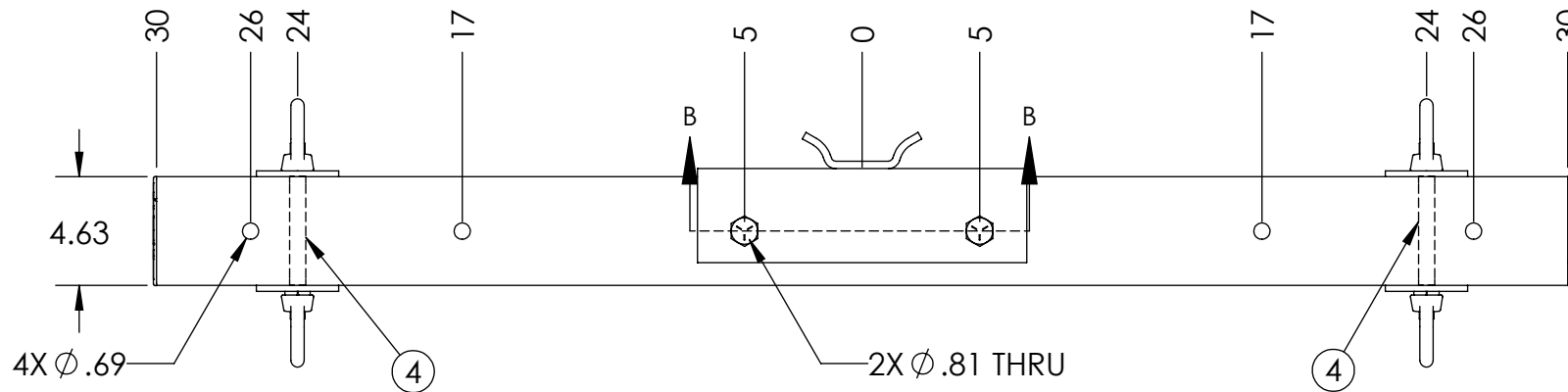
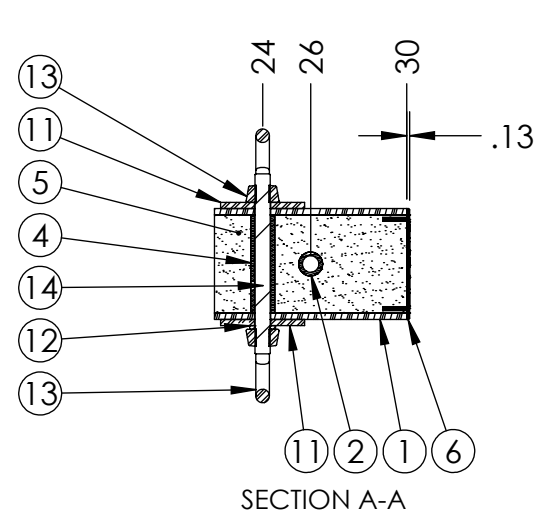
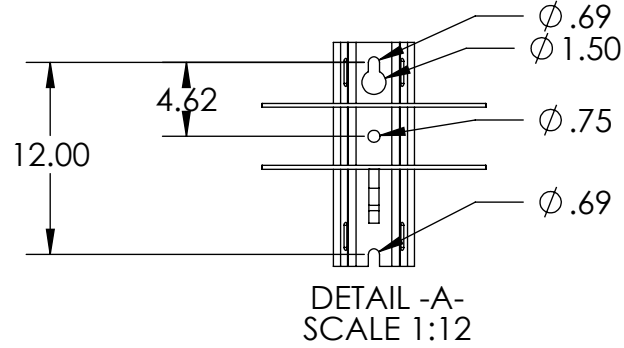

NOTES:
1. CENTER OF MOUNT HOLE(S) TO HOLES TOLERANCE ±0.06

-----UNLESS OTHERWISE SPECIFIED-----
DIMENSIONS ARE IN INCHES
INTERPRET DIM AND TOL PER ASME Y14.5-2009
ANGULAR: MACH ±2°
BEND ±2°
TWO PLACE DECIMAL ±0.02
THREE PLACE DECIMAL ±0.005

PROPRIETARY AND CONFIDENTIAL
THE INFORMATION CONTAINED IN THIS DRAWING IS
THE SOLE PROPERTY OF GEOTEK. ANY REPRODUCTION
IN PART OR AS A WHOLE WITHOUT THE WRITTEN
PERMISSION OF GEOTEK IS PROHIBITED.

STATE: RELEASED 2013-03-14
DRAWN: RAF 2013-02-19
CHECKED: TSK 2013-03-14
APPROVED: TSK 2013-03-14

MATERIAL:
FINISH:
REPLACES:
DA2500-60E2-SPX

THIRD ANGLE PROJECTION

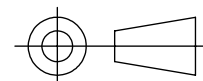

1421 SECOND AVE NW
STEWARTVILLE, MN 55976
(800) 533-1680
www.geotekinc.com

DESCRIPTION:
DEADEND ASSEMBLY, SERIES 2500
60 in, PUPI SPX

SIZE: DWG. NO. **B DA2500060E2SPX2** REV: **1.1**

SCALE: 1:8 WEIGHT: 42.79 LBS SHEET 1 OF 1